



Panasonic®

Fully Automatic Washing Machine

Operating Instructions

Model No. **NA-F70B2**
NA-F65B2

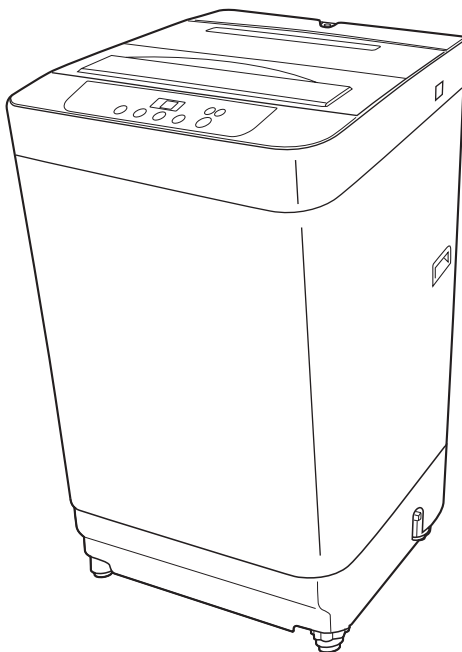

Thank you very much for purchasing Panasonic Product.

Before operating this washing machine, please read these instructions completely,
paying special attentions to Safety & General Precautions.

W9901-7JS00
PHAT1004-0
Printed in Thailand

Contents

ITEM		PAGE
Safety & General Precautions		3-4
Name of parts		5
Procedures before washing		5
Determining load and detergent levels with the Quick Indication		6
Laundry Detergent		6
How to use liquid detergent		7
How to use bleach		7
How to use softener		7
When putting the softener in or removal of the lint filter is difficult.		7
How to use powdered synthetic detergents		8
How to use powdered detergent		8
“Economy” Laundering		8
Laundry Tips		8
Operations Panel		9
Miscellaneous Options	Normal Course	10
	Speedy Course	10
	Delicate Course	11
	Extra Rinse Course	11
	Air Dry 90 min Course / Air Dry 30 min Course	12
	Reserve Program	13
Child Lock program		14
Cancelling end buzzer after washing		14
Choosing Your Own Laundry Setting		15
Maintenance: Tub Hygiene Course		15
Maintenance: Tub Dry		16
Maintenance		16
Please observe the following Instructions		17
Caution		17
How to install		18
Install Washing Machine Horizontally		18
Connect the water supply hose		19
Drain Hose Installation Instruction		20
Bottom Cover Installation Instruction		20
Troubleshooting		21
Error Indication		22
Specification		22



Safety & General Precautions

To prevent the risk of danger or material loss or damage to the user of others, make sure to follow the precautions described below.



WARNING

May cause a serious injury or death.



CAUTION

May cause physical injury or damage other items.



WARNING

Never disassemble, repair or remodel this washing machine.

If you disassemble, repair or remodel the washing machine by yourself, it can cause fire or irregular action that results in injury.

Consult your dealer for repair.



When you are cleaning your washing machine, do not apply water directly to any part of the washing machine.

It will cause short circuit and electric shock.

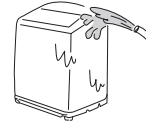

Do not place the washing machine on a damp place such as in a bathroom or exposed to the outside weather.

There is risk of the insulation deteriorating, electric shock and overheating, or breakdowns due to rust.

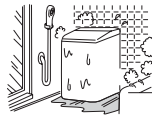

Do not place any burning object including burning candles or cigarettes, on top or near the washing machine.

There is a danger of fire or set deformation.



Never touch the laundry with your hand during spin until the tub has completely stopped spinning.

If you touch the laundry, even if the tub is rotating slowly, there is a danger of injury if the laundry becomes entangled with your hand. Pay particular attention to protecting children from such injury.



Please do not wash or spin laundry which stained with gasoline, kerosene, benzene, paint thinner or the likes of it.

There is a risk of explosion or fire burn.



Do not use power plug socket or wiring equipment more than their rated capacity.

When you use the socket or wiring more than its rated capacity by connecting multiple appliances, it can cause fire due to overheating.

Never disconnect the power plug by pulling the power cord. Hold the power plug as you pull it out.

There is a danger of an electric shock or short circuit which may cause a fire.



Make sure that the ground is attached to the power supply outlet.

Otherwise, there is a danger of electric shock at the time of machine trouble or electricity has leaked.

- Be sure to ask your dealer about grounding work.



Make sure to push the power plug completely into the power supply outlet.

If the power plug is not completely pushed into the outlet, this may cause electric shock and fire due to overheating.

- Never use a damaged power cord.





WARNING

Do not damage the power cord and power plug.

(Do not damage, modify, immoderately bend, twist, pull, or bundle the power cord, do not put the power cord and power plug close to heating appliances, do not put anything heavy on power cord and power plug.)

- If using the damaged power cord it will cause fire and current shortage.
- Consult your dealer about power cord and power plug repairing.

Remove any dust which may accumulate around the power cord.

When dust has accumulated on and around the power plug, and the dust gets damp or wet, the insulation plug become defective and may causes a fire. Pull out the power plug, and wipe off dampness with a dry clean laundry.

- If you are not going to use the washing machine for a long period of time, pull the power plug out of the socket.

Always pull the power plug out of the power supply before doing cleaning or maintenance of the washing machine.

- Otherwise, there is a risk of electric shock or injury.



Do not pull the power plug out of the socket or push in the power plug inside the socket with wet hand.

It will cause electric shock.



CAUTION

This appliance is not intended for use by persons (including children) with reduced physical, sensory or mental capabilities, or lack of experience and knowledge, unless they have been given supervision or instruction concerning use of the appliance by a person responsible for their safety.

Children should be supervised to ensure that they do not play with the appliance.

Do not put your hand or foot under the washing machine while the washing machine is operating.

There is a rotating mechanism at the bottom of the machine, so you could be injured.

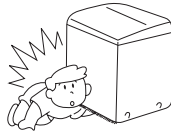

Do not climb up or put anything heavy on the top of the washing machine.

You could be injured due to set deformation or breakage of the washing machine.



Do not wash and spin waterproof sheets and garments.

(Example) Raincoats, outfits (coats/jackets and pants) for fishing and skiing, etc.

The items could be damaged or you could be injured due to irregular vibration during the spin cycle.



Always check the hose connection by turning on the water tap before starting washing.

If the fixing screws are loose, it will cause water leakage that could cause unexpected damage.

Do not use water with temperature above 50°C.

- The plastic parts will become deform, resulting in set breakdown.

Name of parts

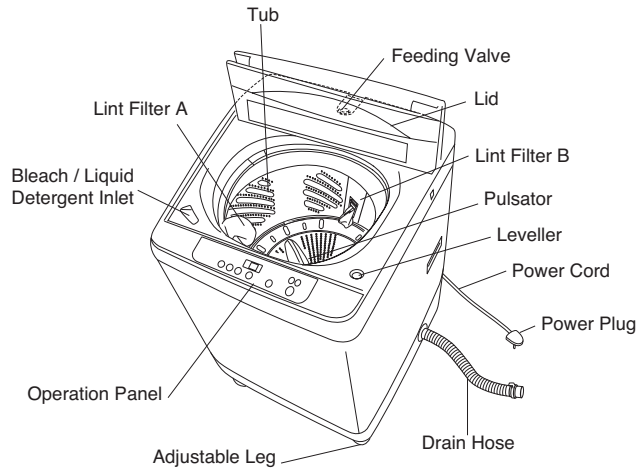

Accessories

Water Supply Hose (1)

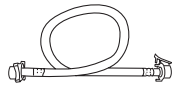

Length: 1.0 m

Water Tap Adaptor (1)



Note: Water Tap Adaptor is set to the Water Supply Hose.

Bottom Cover (1)

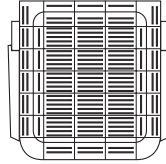

Hose Hole Cover A (1)



Screw (2)
Note: For Bottom Cover

Procedures before washing

- Check the installation

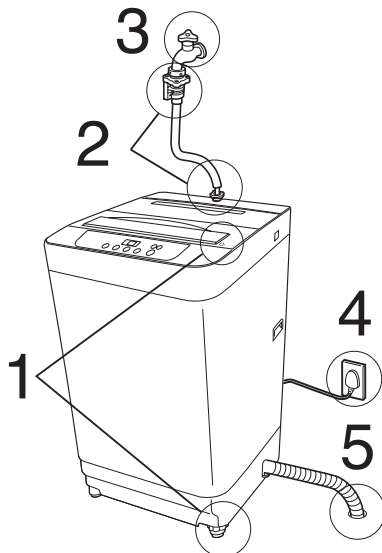

[NOTE]

Before installation, please make sure to install the bottom cover. See page 20 for details.

See pages 18~20 for details.

- Level the washing machine by adjusting the adjustable leg and using the leveller as reference.
- Connect the water supply hose.
- Turn on the faucet.
- Plug power cord into socket outlet.
- Insert the drain hose to drain.

Determining load and detergent levels with the Quick Indication

1 Put the laundry into the machine.



Press the [Power On] button and then press the [Start/Pause] button after putting in the laundry.

2 Allow the machine to churn the laundry for 5 seconds.



The pulsator operates for about 5 seconds without any water in the tub to measure the amount of laundry. If there is already water in the tub, the machine will not operate and the water level will be set to 51L (45L in the case of NA-F65B2).

3 Detergent volume indications.



The display will indicate the appropriate water level to the laundry. Add the appropriate amount of detergent according to the detergent volume indicated.

Detergent indicator

The  indicates the number of scoop of compact powdered laundry detergent formula to be inserted using the measuring scoop in the tub (1 scoop = about 40 grams).

For information concerning other types of laundry detergent, see the table below.

■ The pulsator operates without water in the washing tub in order to measure the amount of laundry.















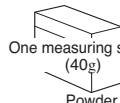

- According to laundry load, put in the detergent then close the lid.
- For better detergent dissolve, put in at the area of water feeding.

■ Change the water level setting in the following cases:

- When placing the wet laundry inside the tub, the water level will be indicated 51L (45L in the case of NA-F65B2) even though the laundry weight is light.
- When you put in light weight laundry or laundry that doesn't absorb water easily (laundry made of synthetic fiber and mixed fiber, etc.).



Laundry Detergent

Detergent type	Synthetic detergents			Powdered detergent
	Concentrated type	Liquid type		
	(25g per 30L of water)	(25ml per 30L of water)	(40ml per 30L of water)	
Water level (Laundry volume)  51L (Approx. 7.0kg)  (NA-F65B2) 45L (Approx. 6.2kg)  41L (Approx. 3.0kg)  33L (Approx. 2.0kg)  24L (Approx. 1.2kg)  18L (Approx. 0.5kg)  16L (Approx. 0.3kg)	 One measuring scoop (40g) Powder	 Concentrated liquid	 Non Concentrated liquid	 Powder
	 1 1/6 scoops	approx. 43ml	approx. 68ml	approx. 68g
	 1 scoop	approx. 38ml	approx. 60ml	approx. 60g
	 1 scoop	approx. 34ml	approx. 55ml	approx. 55g
	 4/6 scoop	approx. 28ml	approx. 44ml	approx. 44g
	 1/2 scoop	approx. 20ml	approx. 32ml	approx. 32g
	 2/6 scoop	approx. 15ml	approx. 24ml	approx. 24g
	 1/6 scoop	approx. 13ml	approx. 21ml	approx. 21g

- The figures in parentheses in the water level column indicate the approximate weight of the laundry load.
- Please use the standard amount of laundry detergent as printed on the detergent container.
- Some laundry detergents have their own prescribed methods of use. Please read the instructions to your laundry detergent.
- When a large quantity of suds is produced, use less detergent or switch to a low-suds detergent.

6



How to use liquid detergent

Put in the liquid detergent according to the water level into the bleach / liquid detergent inlet.

Bleach / Liquid Detergent Inlet



[NOTE]

- Liquid detergent, like powdered detergent is not easily dissolved and can leave scum along the inside of the washing tub, so be sure to rinse thoroughly.

How to use bleach

■ Liquid bleach

- Dilute fully with water and pour in before pressing [Start/Pause].

Bleach / Liquid Detergent inlet



■ Powder bleach

- Place directly into the tub during fill.
- Follow the instruction on the bleach container.

How to use softener

Adding softener

Please put it in before beginning the wash.

- Because the (Concentrated) type is sticky and adheres to the opening, dilute with 3 times the amount of water.
- Pour it in slowly. When it is difficult to add, turn the wash tub to the right to locate the Softener Inlet in a more convenient position (see the following clause for details), or release the cassette case from the Balancer case and pour into it.
- Cassette case can be removed by pulling the top toward inside.

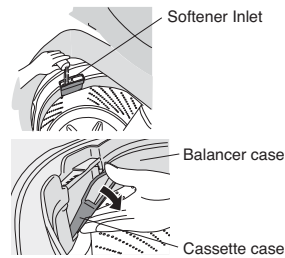

Table of softener quantities

(Normal)20 ml softener per 30L of water.

(Concentrated) ... 6.6 ml softener per 30L of water.

Water level		51L (45L in the case of NA-F65B2)	41L	33L	24L	18L	16L
Softener	Normal	Approx. 34ml (Approx. 30ml)	Approx. 27ml	Approx. 22ml	Approx. 16ml	Approx. 12ml	Approx. 11ml
	Concentrated	Approx. 11ml (Approx. 10ml)	Approx. 9ml	Approx. 7ml	Approx. 5ml	Approx. 4ml	Approx. 4ml

[Please note]

- Please do not let the softener sit in the water for a long time.
- Please do not open the lid during the spin cycle. If the lid is opened, softener will be added too early and then its effectiveness will decrease.
- If rinsed water is used, results will not be as effective.
- Softener is automatically added to the tub at the end of the rinse cycle.

When putting the softener in or removal of the lint filter is difficult.

The wash tub can be turned lightly to a convenient position.

- How to turn the wash tub.
 1. Push the power switch on.
 2. After 15 seconds with a sound "click", rotate the wash tub.

[NOTE]

- The wash tub does not rotate while filled with water.
- The wash tub does not rotate after pushing the [Start/Pause] button.
- The water filled after 15 seconds is drained automatically.





How to use powdered synthetic detergents

POWDERED SYNTHETIC DETERGENT [CONCENTRATED TYPE]

Color transfer and color fading will occur if the detergent directly in contact with the laundry (for a long time) such as when using Soak program or soak the clothes. Please use white handkerchief, etc. to wrap the detergent before put it into the tub.



How to use powdered detergent

How to dissolve

1. Fill the washing machine tub with water one level below the water level that will be used.
(For low water level setting, the same water level will be used.)
2. Add the powdered detergent and let the machine run for about 3 minutes.
3. Put the laundry in and begin washing at the desired level. Set the [Water Level] button.

Dissolving hard-to-dissolve detergent

1. Pour 5 liters of water at about 30°C into a container.
2. Dissolve the detergent by adding it little by little while churning the water.
 - In order to keep it from hardening or sticking, mix it well and dissolve it, then pour it into the washing tub.

[Warning]

- Powdered detergent is not easily dissolved compared to synthetic detergent, be certain to rinse thoroughly. If it is not rinsed well laundry may be tinged with yellow or smell of detergent. If too much detergent is added, or if it is added directly to cold water, scum and clumps which are not completely dissolved will stick to the inside of the tub and hose. These may float up and dirty the laundry.

“Economy” Laundering

Using wash water twice

Wash lightly soiled laundry in the first load.

1. Put the laundry in the tub, and press [Power On] button.
2. Press [Process] button for [Wash] and press [Start/Pause] button.
3. Put in the detergent.
4. Wash finishes.
- * Take the wet laundry out.
8. Put wet laundry which has been washed back into the tub again.
9. Press [Process] button for [Rinse] and [Spin], then press [Start/Pause] button.
10. Close the lid and wait until laundry will be completed.

Wash heavily soiled laundry in the second load.

5. Load the laundry.
6. Press [Power On] button to carry out washing, rinsing and spinning. Add the detergent a little when you increase the water level or refilling water.
7. Wash finishes.
- * Remove the laundry.

Laundry Tips

Brush off laundry before washing them.



Turn inside out any garments which give off lint or lint balls.



Press down lightly on bulky items while the tub is filling with water to get them thoroughly soaked.



Put a little detergent on a brush and lightly scrub the tough stains off collars and cuffs.



Put laundry with lace attached, lingerie, nylon stockings, chemical fiber transparent fabrics etc. in a washing net.



For laundry which has long cord or clasps attached, tie the cords on aprons, pillow covers and the like, and fasten clasps.



Operations Panel

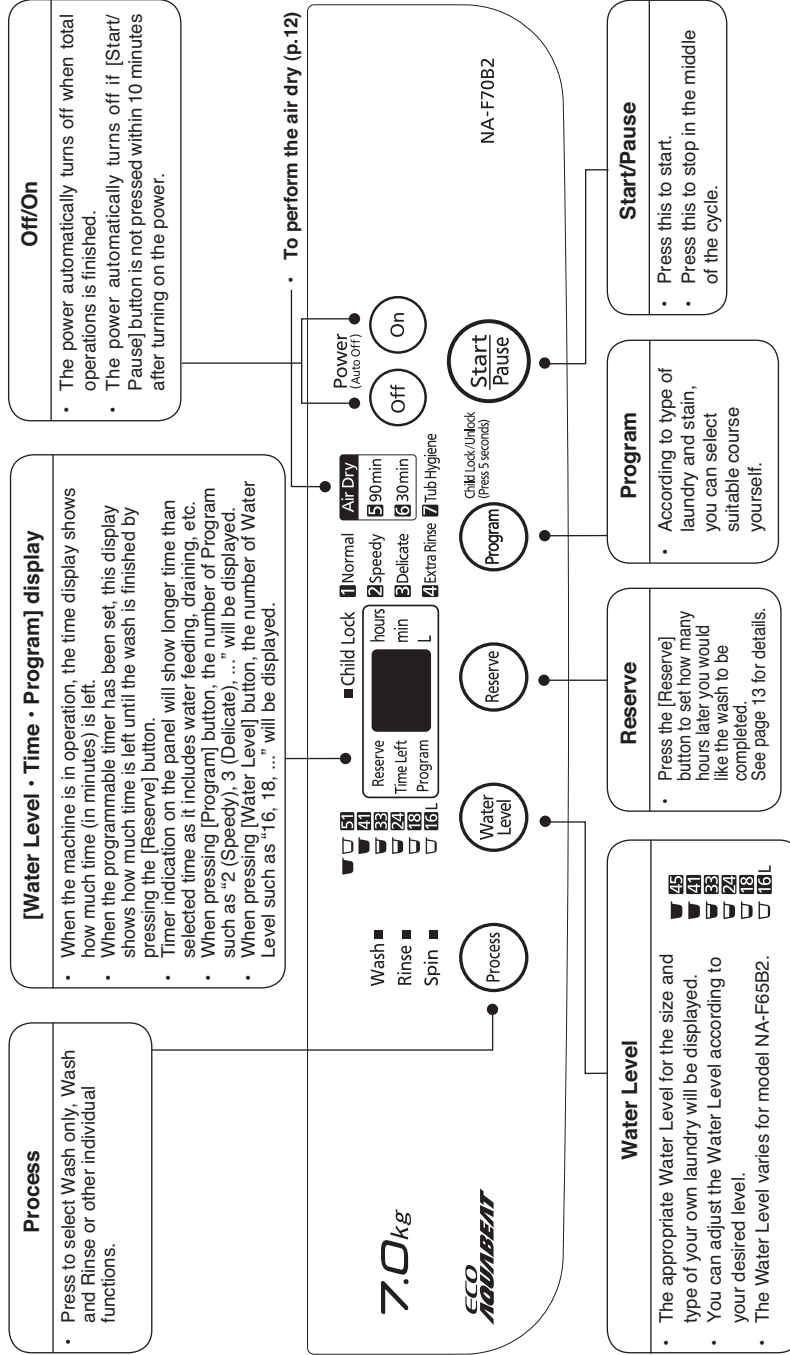

Caution: If you need to change the [Program] settings after the cycle has already started, turn the power Off and On it back.

Normal Course

Suitable for Normal washing of casual laundry.



1 Press the [Power On] button and put in the laundry.

2 Press the [Start/Pause] button.

After pressing the [Start/Pause] button, the machine starts "Laundry sensing". When it is completed, the display indicates the water level with "L" and in a few seconds the remaining time with "min" will be indicated. To check the water level, press the [Water Level] button. To check the course in operation, press [Program] button.

- The display will indicate program "1" for "Normal" Course automatically.
- The machine will measure the load size without water (laundry sensing).
- The water level will be indicated automatically.
- You can adjust the water level according to your desired level.

3 Put in the appropriate amount of detergent for the water level. Then close the lid.

- Add softener. See page 7 for details.

- Different brands of detergent may have different measuring scoops sizes. If the scoop holds other than 40 grams, add the amount of detergent recommended by the detergent makers for the selected water level. See page 6 for details.

The buzzer lets you know when the washing is finished.

Speedy Course

Suitable for washing lightly soiled laundry or quick wash.

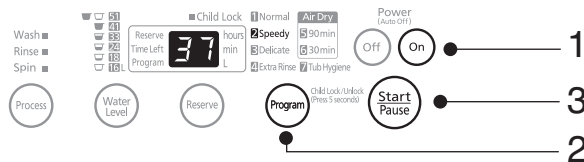

1 Press the [Power On] button and put in the laundry.

2 Press the [Program] button once for selecting "Speedy" Course.

3 Press the [Start/Pause] button.

After pressing the [Start/Pause] button, the machine starts "Laundry sensing". When it is completed, the display indicates the water level with "L" and in a few seconds the remaining time with "min" will be indicated. To check the water level, press the [Water Level] button. To check the course in operation, press [Program] button.

- The display will indicate program "2" for "Speedy" Course.

- The machine will measure the load size without water (laundry sensing).
- The water level will be indicated automatically.
- You can adjust the water level according to your desired level.

4 Put in the appropriate amount of detergent for the water level. Then close the lid.

- Add softener. See page 7 for details.

- Different brands of detergent may have different measuring scoops sizes. If the scoop holds other than 40 grams, add the amount of detergent recommended by the detergent makers for the selected water level. See page 6 for details.

The buzzer lets you know when the washing is finished.

Delicate Course

Suitable for washing soft laundry.

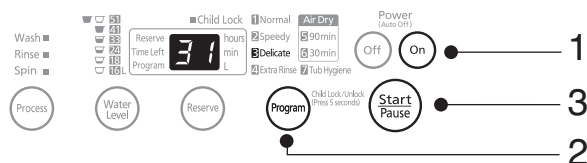

Remark: Amount of laundry that can be washed at one time : 3.5 kg

- 1 Press the [Power On] button and put in the laundry.
 - 2 Press the [Program] button 2 times for "Delicate" Course.
 - The display will indicate program "3" for "Delicate" Course.
 - 3 Press the [Start/Pause] button.
 - Water level will be indicated 41L automatically.
 - Selection for water level only at 41L.
 - 4 Put in the appropriate amount of detergent for the water level. Then close the lid.
 - Different brands of detergent may have different measuring scoops sizes. If the scoop holds other than 40 grams, add the amount of detergent recommended by the detergent makers for the selected water level. See page 6 for details.

■ Add softener. See page 7 for details.
- The buzzer lets you know when the washing is finished.

Extra Rinse Course

For washing with extra rinse cycle, suitable for baby or people with sensitive skin.

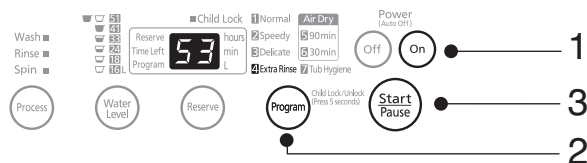

- 1 Press the [Power On] button and put in the laundry.
 - 2 Press the [Program] button 3 times for selecting "Extra Rinse" Course.
 - The display will indicate program "4" for "Extra Rinse" Course.
 - 3 Press the [Start/Pause] button.

After pressing the [Start/Pause] button, the machine starts "Laundry sensing". When it is completed, the display indicates the water level with "L" and in a few seconds the remaining time with "min" will be indicated. To check the water level, press the [Water Level] button. To check the course in operation, press [Program] button.

 - The machine will measure the load size without water (laundry sensing).
 - The water level will be indicated automatically.
 - You can adjust the water level according to your desired level.
 - 4 Put in the appropriate amount of detergent for the water level. Then close the lid.
 - Different brands of detergent may have different measuring scoops sizes. If the scoop holds other than 40 grams, add the amount of detergent recommended by the detergent makers for the selected water level. See page 6 for details.

■ Add softener. See page 7 for details.
- The buzzer lets you know when the washing is finished.

Air Dry 90 min Course / Air Dry 30 min Course

The air dry is the process to provide air flow utilizing the rotation of the tub and dry the laundry with this air flow. (Agitation is performed about every 30 minutes to untangle the laundry.)

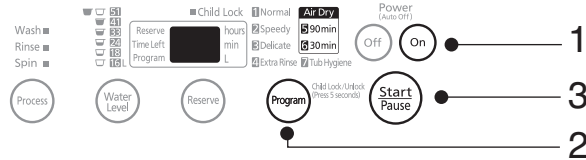

- Remark:
- The laundry may not be dry enough depending on the size of the load, type of clothes, temperature, humidity and installation conditions of the washing machine. (As no heater is used for this function, some users may feel the laundry is cold and not dry.)
 - Some types of clothes cannot be dried with this function. Refer to the following for details.

- 1 Untangle the spun laundry and place them in the tub. Securely close the lid, and then, press the [Power On] button.
- 2 Press the [Program] button 4 times for “Air Dry 90 min” Course and 5 times for “Air Dry 30 min” Course.
 - The display will indicate program “5” for “Air Dry 90 min” Course and program “6” for “Air Dry 30 min” Course.
- 3 Press the [Start/Pause] button.
 - The air dry operation is a timer-controlled program and it completes regardless of how dry the laundry is. If the laundry is not dry enough, perform the air dry operation one more time.
 - The remaining time appears on the display.

The buzzer lets you know when the program is finished.

Clothes for which the air dry function may not be used

- Clothes or fabric with cotton lining, blanket, futon and carpet cover (Damage to laundry or failure of the machine may be caused)
- Wool clothes (Shrinkage or drop of wool fiber may be caused)
- Waterproof-type clothes
- Clothes that easily lose color
- Clothes that easily get wrinkled

Clothes for which the air dry function may be used

→Synthetic clothes (2.0kg)

NOTE:

- If too much clothes are placed in the tub for drying, or depending on the type of synthetics, the clothes may not be dry enough or get wrinkled.
- When drying clothes with button or zipper, an abnormal noise may be heard as the button or zipper may come into contact with the tub.

Reserve Program

You can select the finishing of the washing course between 2 to 24 hours from the current time. (Sometimes the operation exceeding the Reserve time because of the water feeding and draining condition.) [Reserve] program only can use for Normal, Speedy and Extra Rinse Course.

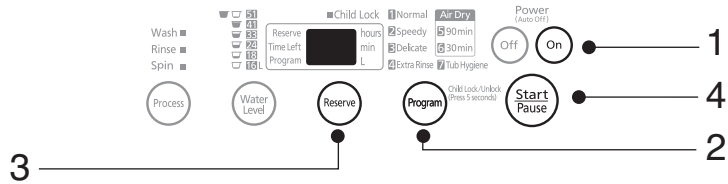

- 1 Press the [Power On] button and put in the laundry.
- 2 Choose the [Program] that suit to your laundry type.
- 3 Press the [Reserve] button and select between 2 to 24 hours.
- 4 Press the [Start/Pause] button.
 - The machine will measure the load size without water (laundry sensing).
 - The water level will be indicated automatically.
- 5 Put in the appropriate amount of detergent for the water level. Then close the lid.
 - The water level indication will go off 5 seconds after starting the program, but only indicate the end time of the selected [Reserve] 2 to 24 hours after current time, which will go off after 2 minutes. Check the recommended detergent amount before the indication goes off.
 - To check the contents of the Reserve operation, keep pressing [Reserve] or [Process] button for the time, [Program] button for the course, and [Water Level] button for the water level. (The indication will go off after 5 seconds even if you keep pressing the button.)

■ Add softener. See page 7 for details.

The buzzer lets you know when the washing is finished.

Child Lock program

This is an emergency alarming mode with a continuous buzzer sounds when child open the lid during operation to prevent a child from drowning (condition where there is a water inside the tub) by falling into the tub which contains water.

Close the lid to stop the buzzer. If the lid is kept open for more than 10 seconds, the machine will force drain the water inside the tub assuming that the child had fallen into the tub but make sure that the drain hose is laid down.

- This is different from the function that lock button operation and the lid.

■ IN THE CASE OF FORCE DRAINING.

There will be an abnormal alarm (flickering of lamps and buzzer). Please check inside the tub.

■ RESET METHOD OF ABNORMAL ALARM.

Button operation cannot be used.

At first, unplug the power cord from the outlet and re-plug it again after 5 seconds.

Please repeat the operation from the beginning because the process had been cancelled.

■ Please do not leave water inside the tub as [Child Lock] mode does not function in the following case:

- In the case of power supply off.
- In the case when forget to lay down the drain hose.
- Please close the lid immediately after press the [Start/Pause] button because when the lid is open, there will be an abnormal alarm and force drain during water feeding.

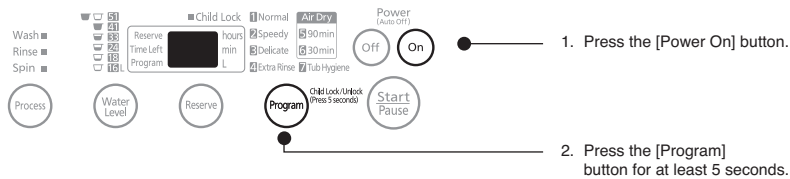

■ SETTING METHOD

1. Press the [Power On] button.
2. Press the [Program] button for at least 5 seconds.

The buzzer sounds (two times for setting) and the [Child Lock] indication turns on.

Remark: [CL] will be indicated on time display only 2 seconds and then it will be turn off.

■ CANCELLING METHOD

Repeat the operation 1 and 2.

The buzzer sounds (4 times for cancelling) and the [Child Lock] indication turns off.

[NOTE]

When you press [Program] button, it switches over, from "Normal" to "Speedy", for example. To set it back to "Normal", turn off the power and turn it on again.

Cancelling end buzzer after washing

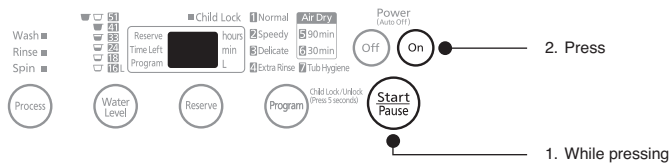

1. Press [Start/Pause] button and [Power On] button at the same time, release [Power On] button and hold [Start/Pause] button at least for 3 seconds. Two times beep sound indicates the end buzzer of washing has been cancelled.
- Repeat step 1 to activate the end buzzer. Four times beep sound indicates the end buzzer has been activated.
- When the power cord is unplugged or a power outage occurs, the last setting of the end buzzer will be remained.

Choosing Your Own Laundry Setting

You can select PROGRAM to wash your own laundry according to your preferences.

<ul style="list-style-type: none"> ■ WASH 	To reuse the wash water. <ul style="list-style-type: none"> • After washing, the wash water is left in the tub and the machine stop operation. • Select the time for washing as desired. • The time selection is depend on the program chosen.
<ul style="list-style-type: none"> ■ RINSE 	To rinse the separately washed laundry. <ul style="list-style-type: none"> • After rinsing, the rinse water is left in the tub and the machine stop operation. • Select the time for rinsing as desired. • The time selection is depend on the program chosen.
<ul style="list-style-type: none"> ■ SPIN 	To spin the separately washed laundry. <ul style="list-style-type: none"> • If the water is left in the tub, it will drain before spinning. • If the lid is opened, it will only drain without spin. • Select the time for spinning as desired. • The time selection is depend on the program chosen.
<ul style="list-style-type: none"> ■ WASH ■ RINSE 	To reuse the rinse water. <ul style="list-style-type: none"> • After washing and rinsing, the rinse water is left in the tub and the machine stop operation. • Select the time for the process as desired. • The time selection is depend on the program chosen.
<ul style="list-style-type: none"> ■ WASH ■ SPIN 	To wash with water (without detergent). <ul style="list-style-type: none"> • The machine will spin automatically without rinsing after washing. • Select the time for the process as desired. • The time selection is depend on the program chosen.
<ul style="list-style-type: none"> ■ RINSE ■ SPIN 	To rinse and spin the laundry soaked with detergent. <ul style="list-style-type: none"> • If the water is left in the tub, it will drain and followed by the intermediate spin before start of rinsing. • Select the time for the process as desired. • The time selection is depend on the program chosen.

- In the case, when [Spin] or [Rinse] [Spin] is selected, if there is water in the tub, the machine will start from draining and if there is no water in the tub, it will start from spinning. So it will take a little while before the machine start operating.
- IN THE CASE WHEN [Child Lock] MODE IS SET.
In some cases, if the lid is opened when the tub contains water, the machine will start force draining. In this case, cancel the [Child Lock] mode.

Maintenance

To prevent fungus growth at the washing and spinning tub.

“Tub Hygiene” Course

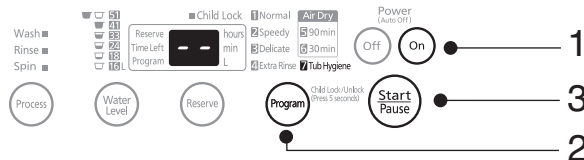

- 1 Press the [Power On] button.
- 2 Press the [Program] button 6 times for “Tub Hygiene” Course.
 - The display will indicate program “7” for “Tub Hygiene” Course.
- 3 Press the [Start/Pause] button.
- 4 When filled up with water, press the [Start/Pause] button, and pour about a cup of chlorine system bleach for clothing use directly into the washing and spinning tub. (Approx. 200ml per 50L of water.)
- 5 Close the lid, and press the [Start/Pause] button.
 - ※ Do not operate while clothing is in the washing tub.
 - ※ Cancel the “Child Lock” when it is active. Refer to page 14.

Operation will be finished in 2 and a half hours.

This is the course to prevent fungus growth at the washing and spinning tub using the “Chlorine system bleach for clothing use”, available in most markets, to keep the tub clean.

- ※ Do not use the oxygen system bleach or chlorine system bleach for kitchen use. (Too much lather may overflow.)
- Frequency for care : Once a month
- Operation will be continued for 2 and a half hours.

[NOTE]

- Fungus growth at the washing and spinning tub varies depending on ambient conditions.



Maintenance

To prevent from fungus growth at the outer tub area.

“Tub Dry”

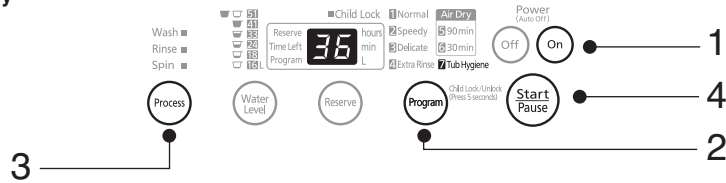

Remark: Please be informed do not put laundry inside the tub during this program.

- 1 Press the [Power On] button.
 - 2 Press the [Program] button 6 times
for [Tub Hygiene] Course.
 - The display will indicate program “7” for “Tub Hygiene” Course.
 - 3 Press the [Process] button once for selecting only “Spin”.
 - 4 Press the [Start/Pause] button.
 - Spinning operation will be operated for 30 minutes
- The buzzer lets you know when the washing is finished.

Maintenance

Lint filter / Water supply hose filter / Main unit and tub

Water supply hose filter

- When water supply seems constricted.
 - Be absolutely sure to follow the procedures as described, otherwise water will spray out.
1. Turn off the water faucet.
 2. Press the [Power On] button.
 3. Press the [Start/Pause] button.
The Water Level will light up a few seconds later.
 4. Press the [Power Off] button to turn off the power.
 5. Loosen the nut.
 6. Take off the hose.
 7. Clean the filter.

Lint filter

- Remove the accumulated lint regularly. When the filter is full of lint, the filter could be torn from rubbing with the laundry during washing cycles.

- | | | | | | |
|---|--|--|--|---|--|
| 1 (Lint filter A)
Remove the lint filter A. | | 2
Remove the lint from the filter. | | 3 (Lint filter A)
Put the filter back in. Make sure it clicks into place. | |
| 1 (Lint filter B)
Pull out the lint filter B from the lock. By using fingers to press and pull out at the upper part of the lint filter's side. | | 3 (Lint filter B)
Set it back to the original position. <ul style="list-style-type: none"> • Insert the bottom first as shown in the figure. • Press down and lock as the arrow. | | | |

- When the filter is torn, etc., obtain another one from the place of purchase.
- Turn the wash tub if the filter cannot be removed easily.

Main unit and tub

- **Main unit**
Wipe with a soft cloth. Use a neutral dishwashing liquid or soap for stubborn places.
 - * Do not apply water directly.
 - * Do not use cleanser, paint benzine, alcohol, kerosene, etc.
 - * Follow any instructions that come with a chemically treated cloth.
- **Upper part of the tub**
Wipe with a damp cloth.
 - * Do not apply water directly.
 - The floor could get wet.





Please observe the following Instructions

If the spinner tub does not stop within 15 seconds after you open the lid during spinning, immediately stop using the machine, and contact your dealer for repair.

Do not spray anything or pour water over the lid.

- Do not put water, pesticides, hair products, deodorants, or any other such liquids on the lid. (To avoid electric shock and malfunctions)



Do not put too much laundry.

- Put laundry completely into the tub. Never allow the laundry to protrude out of the tub. (This causes torn laundry or damage to the plastic parts.)



Do not hold magnets or cards with magnetic strips near the washing machine.

- Do not hold cards with magnetic strips near the washing machine. (The cards may become unusable.)
- Do not hold a magnet near the washing machine while it is in operation. (The tub may stop spinning.)

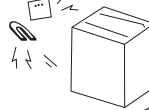

Keep condensation from getting on the floor.

- When the air temperature is high and the water temperature is low, condensation will sometimes run off onto the floor.



Do not put in too much detergent.

- Rinsing cannot be done sufficiently.
- The floor could be wet by the foam flowing out of the machine.



Do not use a cover made of vinyl chloride. (It could damage the plastic or paint.)

- If you intend to use such a cover, first place a cloth over the washing machine to keep it from coming in contact with the cover.

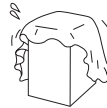

When you will not use the washing machine for a long period of time.

- Turn off the power and pull out the power plug.



Do not put any type of charger stand on the washing machine.

- When you place the charger stand for an electric toothbrush, etc., close to the washing machine, malfunction will result.



After finishing don't forget:-

- Please shut off the faucet.
- Please don't let water store for a long time.
- * This is to prevent water soaking.

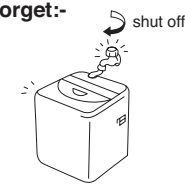

Caution

- It is advisable not to start the machine direct with spinning process but to start with Normal washing cycle.
- Please be aware, when the laundry is unbalanced during spinning, some knocking sound may occur and the spin may stop followed by an additional automatic rinsing.
- If the unbalance condition continue for 3 times, the washing machine will stop functioning automatically.
- You can manually distribute the laundry evenly to ensure the laundry are balanced inside the tub.

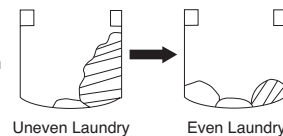

Cautions on parts

If the supply power cord is damaged. It must be replaced by Service Center or a similarly qualified person in order to avoid a hazard.





How to install

In the event that the installation, test run and inspection of the washing machine are not carried out following the installation method outlined in this manual, the manufacturer will not be liable for any accident or damage caused.

Placement

- Do not install the washing machine in any extremely damp place such as a bathroom, or in a place exposed to the weather. There is a danger of electric shock, fire, machine trouble and deformation of machine.
- If machine is installed on the floor, be sure that carpet does not block any openings to prevent it from closing any ventilation openings.
- Do not install the washing machine exposed to direct sunlight (This could cause machine trouble, deformation and other problem.)

Power cord

- Make sure to push the power plug completely into the socket outlet. If the power plug is not completely pushed into the outlet, this will cause electric shock and fire due to overheating.

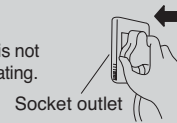

Socket outlet

Establish a ground (In case of two-wire power cords)

- When there is a grounding receptacle on power supply outlet.
- When carbon ground rod (sold separately) is used.
- Do not connect to gas pipe, water pipe, or ground wire of telephone or lighting rod.
- Reestablish a ground when you change installation location or move.
- For further information, contact the distributor or service technician.



WARNING

Make sure to establish a ground.
There is a risk of electric shock caused by a leakage of electricity.

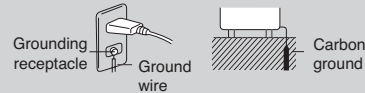

Install The Washing Machine Horizontally

1 Place the washing machine on a flat and secure location.

2 Open the lid, leveller is already fix on the Plastic Body surface. Visually check that the bubble of the leveller is inside the mark from the front and top.

When the bubble is inside the mark

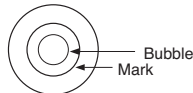

- There is no need to make a height adjustment.

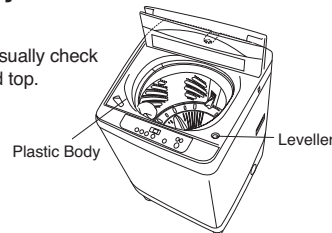

3 Adjust height

When the bubble is largely out of mark

- The floor is largely inclined against the direction that the bubble is leaning.
- Let the bubble inside the mark by placing a board under the leg on the other side.



When the bubble is a little out of mark

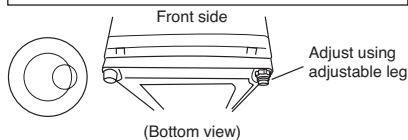

1. Turn the Adjustable Leg Knob towards (LOOSEN) direction to loose it.
2. Turn the Adjustable Leg to adjust the levelness.
 - When increasing height, turn Adjustable Leg towards (LOOSEN) direction.
 - When decreasing height, turn Adjustable Leg towards (TIGHTEN) direction.
3. Turn the Adjustable Leg knob towards (TIGHTEN) direction to tighten it.

Adjustable leg knob

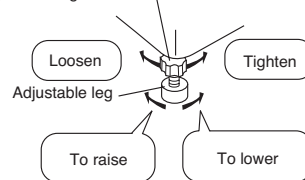

4 Check the machine for unsteadiness and tightens the adjustable leg knob.



Connect the water supply hose

That the appliance is to be connected to the water faucet using new water tap adaptor and water supply hose and that old one should not be reused.

1. Loosen the 4 screws on the water tap adaptor just enough to slip the adaptor over the mouth of the faucet.
2. Slip the water tap adaptor over the faucet, keeping it in a straight line with the faucet. Tighten the screws, applying even pressure all around. When the space behind washing machine is narrow due to a wall or other obstacle, adjust the back screw to the proper position before slipping the connector over the faucet.
3. Remove the tape and tighten B by turning it to the right.
4. With the water supply hose cover and lever pushed down, slide the hose up onto the proper position release them before hear it click into place.
5. Pull down on the hose to make sure it will not come off.
6. Turn on the water faucet to check for leaks.

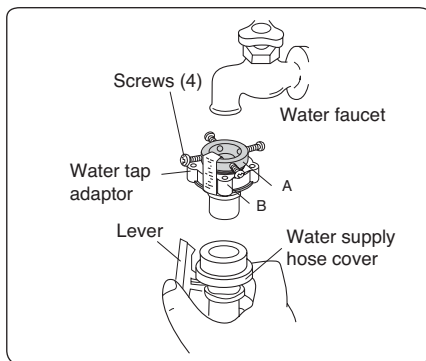

[Note]

- Firmly tighten part B of the water tap adaptor, otherwise water leakage will result.
- If a water tap adaptor is already connected, replace with the attached new one.
- When the hose must be reinstalled (after you remove, for example), turn B to the left until about 4 mm of the thread becomes visible, then carry out the procedure described above.

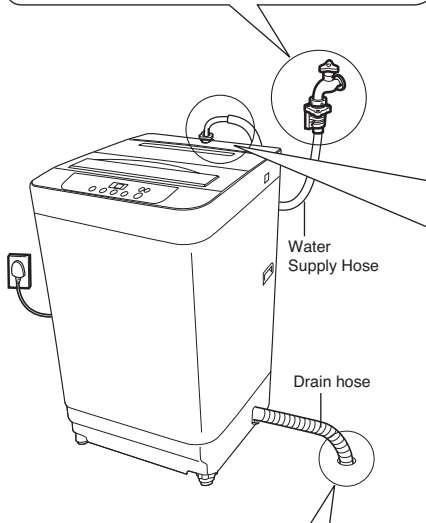
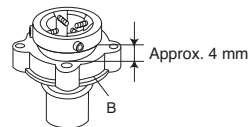

Connect the water supply hose to the water supply valve screw.

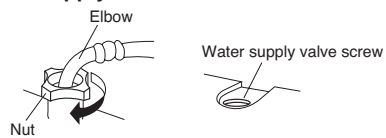

1. Push the water supply hose nut straight onto the water supply valve screw.
2. Hold the elbow by lifting it up, screw the nut onto the water supply valve screw, and firmly tighten the nut.
3. After the nut is tightened, check whether or not the elbow is unsteady or loose.
4. After tightening, open the faucet to confirm that there is no water leakage.

[Cautions]

- Firmly tighten the nut, otherwise water leakage will result.
- Water Pressure Rating : $2.9 \times 10^4 - 9.8 \times 10^5$ Pa

Hose extension

If extended external part is necessary when connecting the drain hose, the length of the drain hose should be less than 3 m and the height should be below 10 cm.

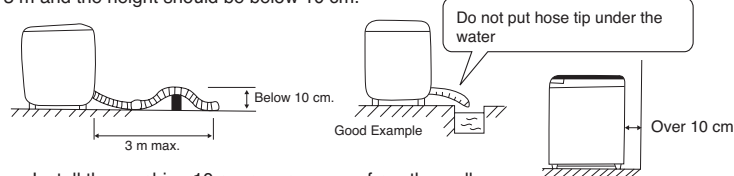

Install the machine 10 cm or more away from the wall.



Drain Hose Installation Instruction

(The drain hose is installed inside the bottom of the base.)

1. Lay down the washing machine with the back body facing to the upside.
2. Peel off the tape and pull out the drain hose from the base.

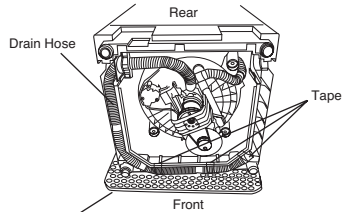

Spread a mat such as cardboard under the body to avoid scratches.

■ To change the drain hose to opposite.

1. Lay down the washing machine with the back body facing to the upside.
2. Remove the screw fixing the hose holder.

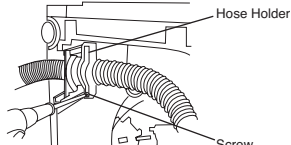

3. Remove the hose holder from the base.

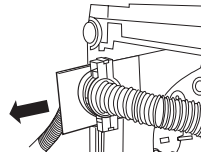

Caution
Make sure the hose holder is fixed on the base properly to avoid water leaking caused of the hose damaged.

Note
Make sure to remount the bottom cover after pulling out the drain hose or changing its position.

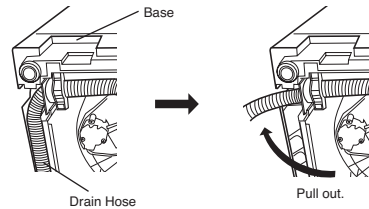

(Ex. Changing hose position from right to left.)

4. Move the hose holder to opposite side. Then insert the hose holder to left hose outlet position of the base.

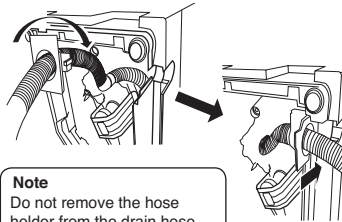

Note
Do not remove the hose holder from the drain hose.

5. Fix the hose holder with screw properly.

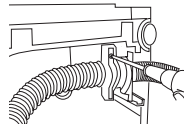

Note
Make sure the drain hose is not twisted.

Bottom Cover Installation Instruction

A. Purpose

For safety precaution.

B. How to install Bottom Cover to the Base

1. Lay down the washing machine with the back body facing to the upside.
2. Adjust the Hose Hole Cover A (accessory) to the slot at the base.
3. Fix Bottom Cover (accessory) where surface with UP indication is facing to the washing machine. And slide down the bottom tip of the Bottom
4. Securely fasten the 2 screws of the Bottom Cover to the Base.

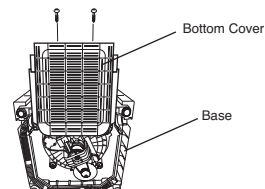
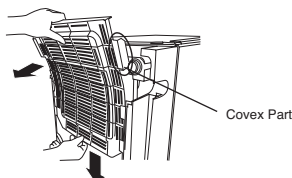
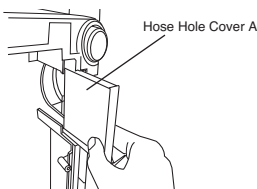

20





Troubleshooting

The following symptoms are not trouble.

Symptoms	Causes
Machine begins filling water in the middle of the wash.	<ul style="list-style-type: none">When the laundry amount is large at the HIGH water level, the machine sometimes fills automatically. When level goes down, the machine fills automatically.
The water level is too high for the amount of laundry being washed.	<ul style="list-style-type: none">When the laundry is already soaked with water before the wash is started, or if there is water in the tub before the wash is started, the water level will sometimes be higher.
The water level is too low for the amount of laundry being washed.	<ul style="list-style-type: none">With light laundry made of synthetic or blended fabric, the water level will sometimes be lower.
Midway during spinning, the operation suddenly changes to rinsing.	<ul style="list-style-type: none">When the laundry is unbalanced during spin, rinsing and automatic correction of unbalanced laundry will begin. Later spinning will return to Normal condition.
The water is drained even filled by a bucket.	<ul style="list-style-type: none">Do not leave more than 15 seconds while powered on. Fill the water while powered off or after pushing the start button.
During draining, the laundry and the spinner rotates with irregular movements.	<ul style="list-style-type: none">To suppress detergent suds build-up, the washing tub turns slowly and quickly.
The buttons do not work.	<ul style="list-style-type: none">Only the [Water Level] button is available after the machine begins washing.To change the setting, press the [Power Off] button and reconfigure the setting.
If you start with the rinse cycle, the tub is not filled with water.	<ul style="list-style-type: none">When there is water in the tub, the operation starts with the draining. After spin cycle is finished, the tub will be filled with water.
Water does not flow through the lint filter. Double Cascade does not operate.	<ul style="list-style-type: none">When the water level is set to very low, water sometimes will not flow through the lint filter. Double Cascade does not operate when these settings have been selected.
Washing machine does not run at all.	<ul style="list-style-type: none">Check if there is power failure.Check if the power fuse has blown out or the breaker is actuated.Check if the power plug is plugged in thoroughly.Check if the "Power Switch" has been pressed.Has the water faucet been turned on?Check if the [Start/Pause] button has been pressed.Has the machine been programmed under [Reserve] timer?
Water is not supplied.	<ul style="list-style-type: none">Check if the water faucet is turned on.Is the water supply cut off?Check if the connection of the water supply hose is clogged with dirt.Please refer to page 16 for cleaning water supply hose filter.
Washing operation still continue even though the expected finishing time had passed on Reserve Program.	Washing time will be longer because of laundry unbalance, water feeding and draining condition.
Buzzer sounds followed by a draining when opening the lid during wash and rinse.	In the case when open the lid after setting the [Child Lock] mode, it will force the draining process. Pull out the power plug from the outlet and replug it after 5 seconds.
Buzzer sounds when opening the lid during cascade rinsing or spinning.	This is a reminder for a user not to put a hand and/or any object into the tub. It is not out of order. * To turn off the buzzer, close the lid.
Tub shaking with the sound of water.	This is the sound of the liquid to maintain the balance during spinning.
Water supply failure.	Normally after the water supply failure, the water will become muddy. Detach the water feeding hose and turn on the water faucet to release to due muddy water. Fix water hose and start washing.
Power failure.	In this case, [Power On] and [Start/Pause] buttons need to be pressed again after electricity is restored. Then the machine will resume operation automatically from beginning of the stopped process.



Error Indication

If the following indications appear on the display panel (buzzer sounds, U and H Characters appear).

U11	<ul style="list-style-type: none"> • Check if abnormalities listed below are seen in the external water hose. • Is the hose connected? • Is it clogged with lint? • Is it crushed? • Is the tip soaked in water? • Is a part of hose at a height of over 10 cm midway? • Is the extension hose longer than 3 m? • Is the hose being used too small? 	} Restart with opening and closing the lid.
U12	<ul style="list-style-type: none"> • Check if the lid is opened. • Close the lid. 	
U13	<ul style="list-style-type: none"> • Is the washing machine in an unsteady position, or is it on an inclined floor surface? • Is the laundry unevenly distributed in the tub? • Arrange the laundry evenly in the tub, then close the lid. 	
U14	<ul style="list-style-type: none"> • Check if you have forgotten to connect the water hose and to turn on the faucet. • Is the water supply cut off? 	} Restart with opening and closing the lid.
U99	<ul style="list-style-type: none"> • Check if lid is open when draining operation of the [Child Lock] program is ON. <p>See page 14 for the reset method of an alarm.</p>	
H01	<ul style="list-style-type: none"> • In case of H displays such as "H01", with no buzzer sounds pull out the power plug, and contact your dealer for service. 	

Specification

Model	NA-F65B2		NA-F70B2	
	Voltage	220 – 240 V~	230 V~	220 – 240 V~
	50 Hz	60 Hz	50 Hz	60 Hz
Power consumption	420 W	460 W	420 W	460 W
Standard water amount	45 L		51 L	
Maximum capacity	6.5 kg		7.0 kg	
Length of power cord	(Approx. 1.6 m)		(Approx. 1.6 m)	
W x L x H	563 x 560 x 945 (mm)		563 x 560 x 945 (mm)	
Net weight	31 kg		31 kg	

Panasonic Corporation

<http://panasonic.net>

© Panasonic Home Appliances (Thailand) Co., Ltd. 2010